



■ Features

- Constant Voltage + Constant Current mode output
- Plastic housing with Class II design
- Built-in active PFC function
- Class 2 power unit
- No load power consumption <0.15W
- P67 rating for indoor or outdoor installations
- Typical lifetime>50000 hours
- 5 years warranty

■ Applications

- LED panel lighting
- LED downlight
- LED decorative lighting
- LED tunnel lighting
- Moving sign
- Type “HL” for use in Class I, Division 2 hazardous (Classified) location

■ Description

NPF-60 series is a 60W AC/DC LED driver featuring the dual modes constant voltage and constant current output. NPF-60 operates from 90~305VAC and offers models with different rated voltage ranging between 12V and 54V. Thanks to the high efficiency up to 90%, with the fanless design, the entire series is able to operate for -40°C ~ +85°C case temperature under free air convection. The entire series is rated with IP67 ingress protection level and is suitable to work for a variety of applications at dry, damp or wet locations.

■ Model Encoding

NPF - 60 - 24

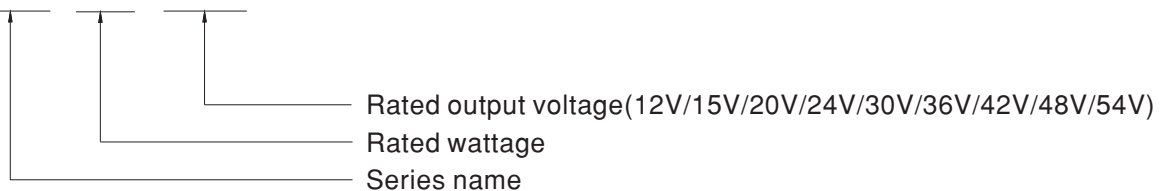

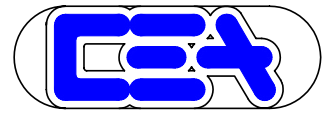

60W Constant Voltage + Constant Current LED Driver

NPF-60 series

SPECIFICATION

MODEL	NPF-60-12	NPF-60-15	NPF-60-20	NPF-60-24	NPF-60-30	NPF-60-36	NPF-60-42	NPF-60-48	NPF-60-54	
OUTPUT	DC VOLTAGE	12V	15V	20V	24V	30V	36V	42V	48V	54V
	CONSTANT CURRENT REGION <small>Note.2</small>	7.2 ~ 12V	9 ~ 15V	12 ~ 20V	14.4 ~ 24V	18 ~ 30V	21.6 ~ 36V	25.2 ~ 42V	28.8 ~ 48V	32.4 ~ 54V
	RATED CURRENT	5A	4A	3A	2.5A	2A	1.67A	1.43A	1.25A	1.12A
	RATED POWER <small>Note.5</small>	60W	60W	60W	60W	60W	60.12W	60.06W	60W	60.48W
	RIPPLE & NOISE (max.) <small>Note.3</small>	150mVp-p	150mVp-p	150mVp-p	150mVp-p	200mVp-p	200mVp-p	200mVp-p	200mVp-p	350mVp-p
	VOLTAGE TOLERANCE <small>Note.4</small>	±4.0%	±4.0%	±4.0%	±3.0%	±3.0%	±2.0%	±1.0%	±1.0%	±1.0%
	LINE REGULATION	±0.5%	±0.5%	±0.5%	±0.5%	±0.5%	±0.5%	±0.5%	±0.5%	±0.5%
	LOAD REGULATION	±1.5%	±1.0%	±1.0%	±0.5%	±0.5%	±0.5%	±0.5%	±0.5%	±0.5%
	SETUP, RISE TIME <small>Note.6</small>	500ms, 80ms 115VAC / 230VAC								
HOLD UP TIME (Typ.)	16ms/230VAC 16ms/115VAC									
INPUT	VOLTAGE RANGE <small>Note.5</small>	90 ~ 305VAC 127 ~ 431VDC (Please refer to "STATIC CHARACTERISTIC" section)								
	FREQUENCY RANGE	47 ~ 63Hz								
	POWER FACTOR	PF ≥ 0.97/115VAC, PF ≥ 0.95/230VAC, PF ≥ 0.92/277VAC@full load (Please refer to "POWER FACTOR (PF) CHARACTERISTIC" section)								
	TOTAL HARMONIC DISTORTION	THD < 20% (@load ≥ 60%/115VAC, 230VAC; @load ≥ 75%/277VAC) (Please refer to "TOTAL HARMONIC DISTORTION(THD)" section)								
	EFFICIENCY (Typ.)	86%	87%	88%	89%	90%	90%	90%	90%	90%
	AC CURRENT	0.8A / 115VAC			0.4A / 230VAC		0.32A/277VAC			
	INRUSH CURRENT(Typ.)	COLD START 50A(twidth=270µs measured at 50% Ipeak) at 230VAC; Per NEMA 410								
	MAX. No. of PSUs on 16A CIRCUIT BREAKER	8 units (circuit breaker of type B) / 16 units (circuit breaker of type C) at 230VAC								
	LEAKAGE CURRENT	<0.25mA / 277VAC								
NO LOAD POWER CONSUMPTION	<0.15W									
PROTECTION	OVER CURRENT	95 ~ 108% Constant current limiting, recovers automatically after fault condition is removed								
	SHORT CIRCUIT	Hiccup mode, recovers automatically after fault condition is removed								
	OVER VOLTAGE	15 ~ 17V	17.5 ~ 21V	23 ~ 27V	28 ~ 34V	34 ~ 40V	41 ~ 46V	46 ~ 54V	54 ~ 60V	59 ~ 66V
	OVER TEMPERATURE	Shut down o/p voltage, re-power on to recover								
ENVIRONMENT	WORKING TEMP.	Tcase=-40 ~ +85°C (Please refer to "OUTPUT LOAD vs TEMPERATURE" section)								
	MAX. CASE TEMP.	Tcase=+85°C								
	WORKING HUMIDITY	20 ~ 95% RH non-condensing								
	STORAGE TEMP., HUMIDITY	-40 ~ +80°C, 10 ~ 95% RH								
	TEMP. COEFFICIENT	±0.03%/°C (0 ~ 50°C)								
VIBRATION	10 ~ 500Hz, 5G 12min./1cycle, period for 72min. each along X, Y, Z axes									
SAFETY & EMC	SAFETY STANDARDS <small>Note.8</small>	UL8750(type"HL"), UL879(for 12V,24V only), CSA C22.2 No. 250.13-12, ENEC EN61347-1, EN61347-2-13 independent, EN62384, IP67 approved; Design refer to EN60335-1								
	WITHSTAND VOLTAGE	I/P-O/P:3.75KVAC								
	ISOLATION RESISTANCE	I/P-O/P:100M Ohms / 500VDC / 25°C / 70% RH								
	EMC EMISSION <small>Note.8</small>	Compliance to EN55015,EN61000-3-2 Class C (@load ≥ 60%); EN61000-3-3								
EMC IMMUNITY	Compliance to EN61000-4-2,3,4,5,6,8,11; EN61547, light industry level (surge immunity Line-Line 2KV)									
OTHERS	MTBF	1178.7K hrs min. Telcordia SR-332 (Bellcore); 367.46Khrs min. MIL-HDBK-217F (25°C)								
	DIMENSION	150*53*35mm (L*W*H)								
PACKING	0.49Kg;30pcs/15.7Kg/1.0CUFT									
NOTE	<ol style="list-style-type: none"> All parameters NOT specially mentioned are measured at 230VAC input, rated current and 25°C of ambient temperature. Please refer to "DRIVING METHODS OF LED MODULE". Ripple & noise are measured at 20MHz of bandwidth by using a 12" twisted pair-wire terminated with a 0.1uf & 47uf parallel capacitor. Tolerance : includes set up tolerance, line regulation and load regulation. De-rating may be needed under low input voltages. Please refer to "STATIC CHARACTERISTIC" sections for details. Length of set up time is measured at first cold start. Turning ON/OFF the driver may lead to increase of the set up time. The driver is considered as a component that will be operated in combination with final equipment. Since EMC performance will be affected by the complete installation, the final equipment manufacturers must re-qualify EMC Directive on the complete installation again. The model certified for CCC(GB19510.14, GB19510.1, GB17743 and GB17625.1) is an optional model . Please contact MEAN WELL for details. This series meets the typical life expectancy of >50,000 hours of operation when Tcase, particularly (Tc) point (or TMP, per DLC), is about 75°C or less. Please refer to the warranty statement on MEAN WELL's website at http://www.meanwell.com 									

File Name:NPF-60-SPEC 2017-10-09



Note: all features are subject to change without notice.

■ BLOCK DIAGRAM

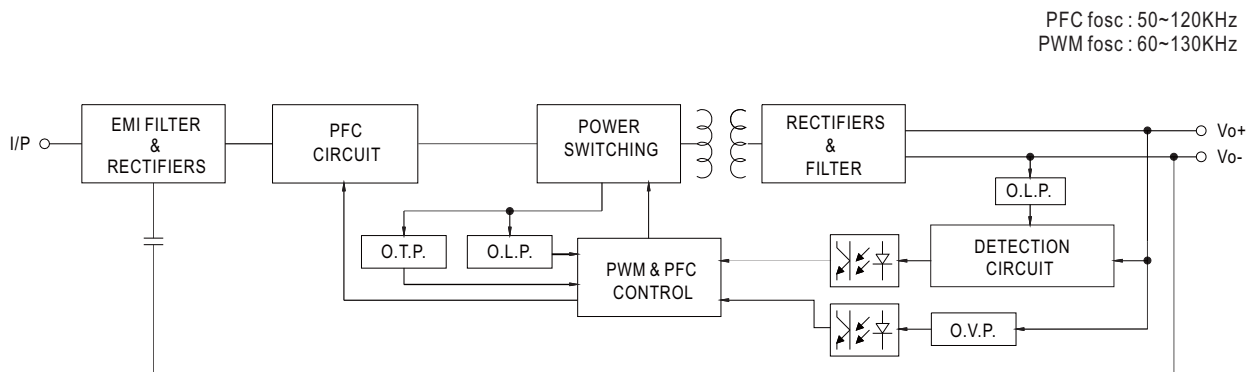

■ DRIVING METHODS OF LED MODULE

※ This series is able to work in either Constant Current mode (a direct drive way) or Constant Voltage mode (usually through additional DC/DC driver) to drive the LEDs.

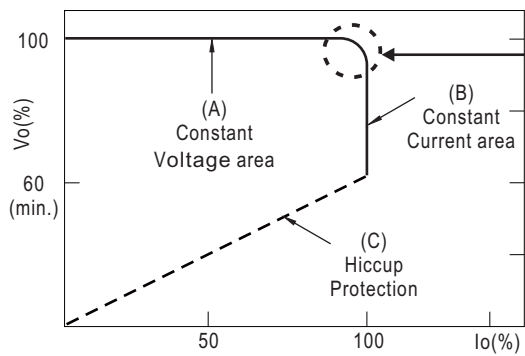

Typical output current normalized by rated current (%)

In the constant current region, the highest voltage at the output of the driver depends on the configuration of the end systems.
Should there be any compatibility issues, please contact MEAN WELL.

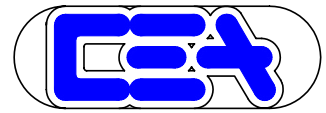

60W Constant Voltage + Constant Current LED Driver

NPF-60 series

OUTPUT LOAD vs TEMPERATURE

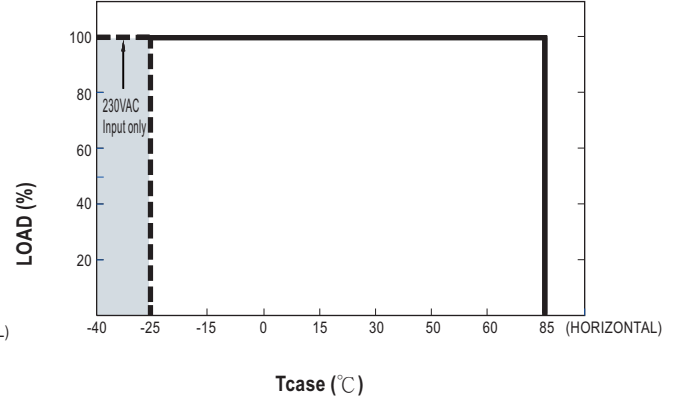
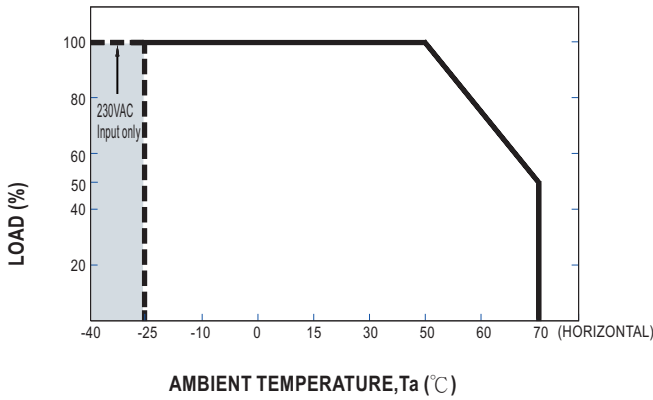

STATIC CHARACTERISTIC

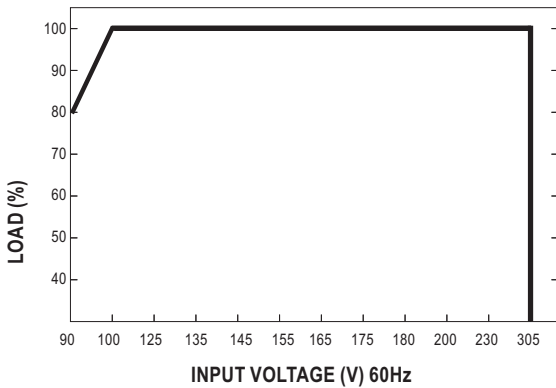

※ De-rating is needed under low input voltage.

POWER FACTOR (PF) CHARACTERISTIC

※ Tcase at 75°C

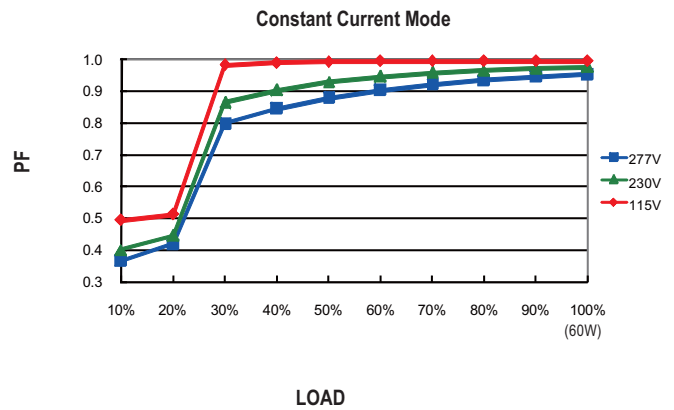

TOTAL HARMONIC DISTORTION (THD)

※ 48V Model, Tcase at 75°C

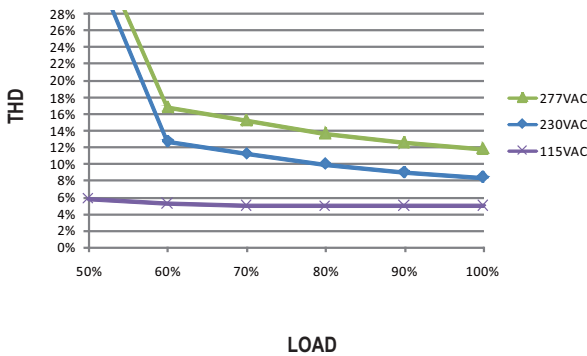

EFFICIENCY vs LOAD

NPF-60 series possess superior working efficiency that up to 90% can be reached in field applications.

※ 48V Model, Tcase at 75°C

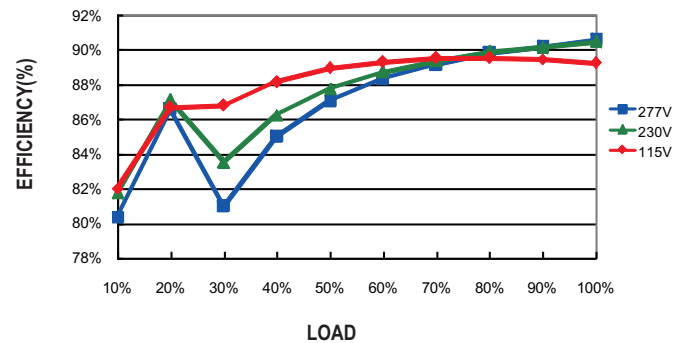

File Name:NPF-60-SPEC 2017-10-09



Note: all features are subject to change without notice.

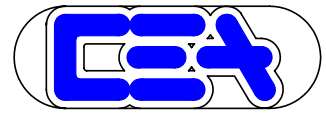

60W Constant Voltage + Constant Current LED Driver

NPF-60 series

■ LIFE TIME

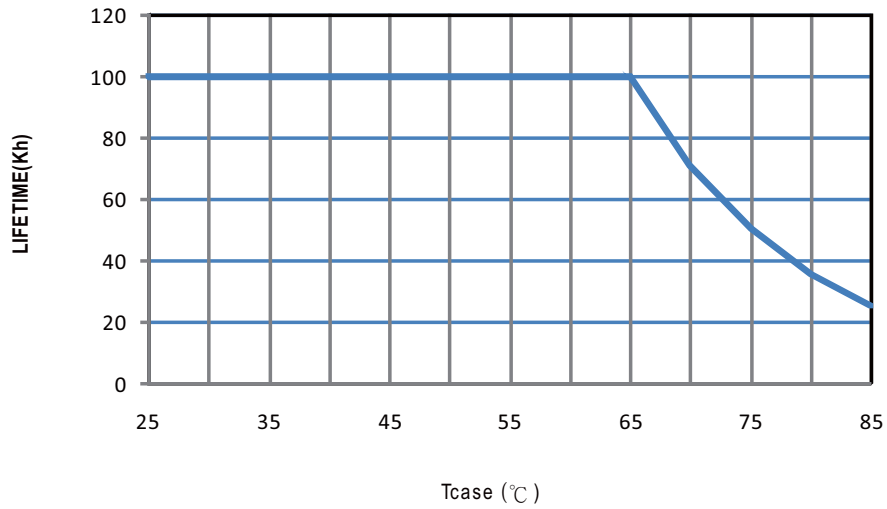

File Name:NPF-60-SPEC 2017-10-09



Note: all features are subject to change without notice.

MECHANICAL SPECIFICATION

CASE NO.: NPF-60A Unit:mm

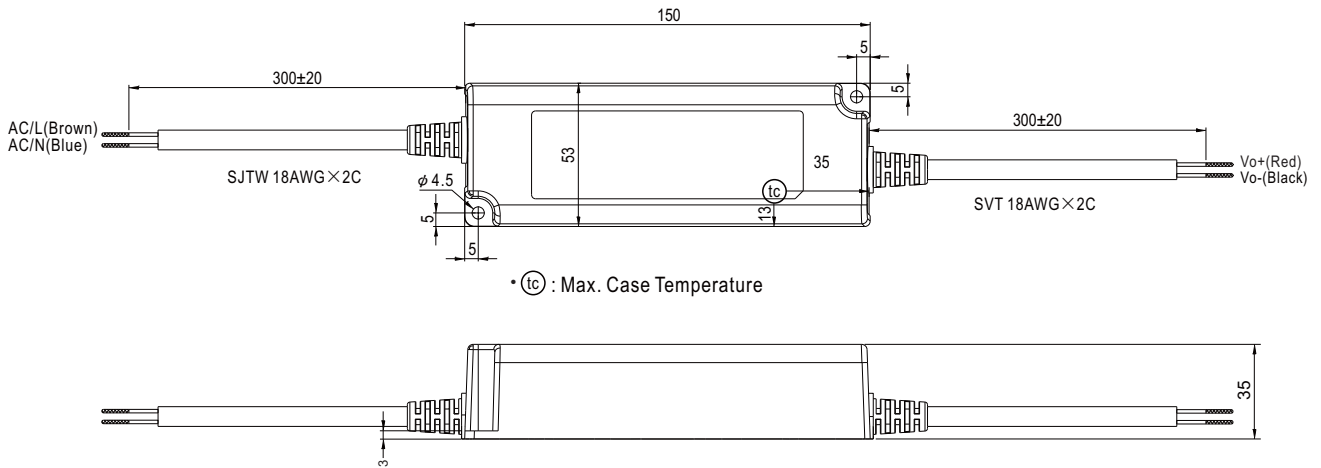

INSTALLATION MANUAL

Please refer to : <http://www.meanwell.com/manual.html>